

HOOKS

With Product Warning And Application Information

G80 HOOKS



Forged super steel - Quenched Tempered.

Suitable for G80 China 80

Individually proof test at 2.5 times Working Load Limit.
2.5

Fatigue tested at 1.5 times Working Load Limit for 20000 cycles.
20000

Breakage twist.

100% magnaflux crack detection 100%

Colour code(): Powder plastified()

Ultimate load is 4 times the Working Load Limit.
4

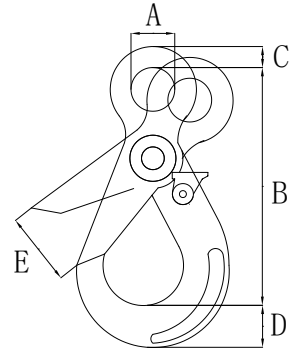

KLR-001 G80 EUROPEAN TYPE EYE SELF-LOCKING HOOK G80

		T	MM					KG
			A	B	C	D	E	
KLR-001-6	6-8	1.12	22	110	10	19.5	28	0.5
KLR-001-8	8-8	2	25	136	12	24	34	0.8
KLR-001-10	10-8	3.15	32	171	15	28.5	44	1.55
KLR-001-13	13-8	5.3	40.5	208	19.5	40	52	3.2
KLR-001-16	16-8	8	56	257	22	50.5	60	5.75
KLR-001-20	20-8	12.5	64.5	275	27	55	81	8.5
KLR-001-22	22-8	15	70	320	30	67	82	13
KLR-001-26	26-8	21.2	80	363	34	75	110	18
KLR-001-32	32-8	31.5	105	472	45	97	168	44.5



Forged super steel - Quenched Tempered.

Suitable for G80 China 80

Individually proof test at 2.5 times Working Load Limit.
2.5

Breakage twist.

100% magnaflux crack detection 100%

All load pins are 100% individually inspected and tested.
100%

Colour code(): Powder plastified()

Ultimate load is 4 times the Working Load Limit.
4

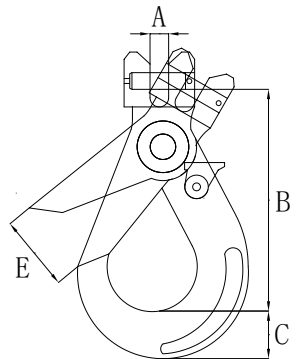

KLR-002 G80 EUROPEAN TYPE CLEVIS SELF-LOCKING HOOK G80

		T	MM				KG
			A	B	C	E	
KLR-002-6	6-8	1.12	8.5	95.5	19.5	29	0.5
KLR-002-8	8-8	2	9.5	121	24	34	0.8
KLR-002-10	10-8	3.15	12	146	28.5	44	1.5
KLR-002-13	13-8	5.3	15	182	40	52	2.8
KLR-002-16	16-8	8	18	218	50.5	60	5.6
KLR-002-20	20-8	12.5	25	240	55	83	7.5
KLR-002-22	22-8	15	25.5	276.5	67	88	11.5
KLR-002-26	26-8	21.2	30	310.5	75	95.5	18.5
KLR-002-32	32-8	31.5	35.5	400.5	97	160	49.1

Never exceed Working Load Limit

G80 HOOKS



Forged super steel - Quenched Tempered

Suitable for G80china 80

Individually proof test at 2.5 times Working Load Limit.

2.5

Fatigue tested at 1.5 times Working Load Limit for 20000 cycles.

20000

Breakage twist.

100% magnaflux crack detection 100%

Surface code(): Powder plastified()

Ultimate load is 4 times the Working Load Limit.

4

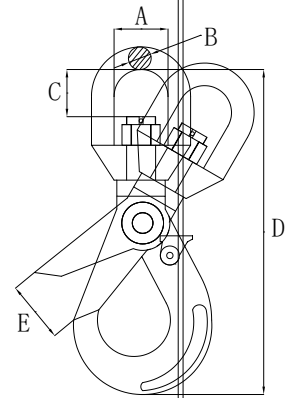

KLR-003 G80 EUROPEAN TYPE SWIVEL SELF-LOCKING HOOK G80

		T	MM					KG
			A	B	C	D	E	
KLR-003-6	6 8	1.12	32.5	11.25	22	170	29	0.71
KLR-003-8	8 8	2	35.5	12.5	26	210	34	1.1
KLR-003-10	10 8	3.15	42	15	34	247	44	2.0
KLR-003-13	13 8	5.3	50	16	38.5	302	52	4.0
KLR-003-16	16 8	8	61	21.5	55	383	60	7.3
KLR-003-20	20 8	12.5	72	26	61	418	83	11.6
KLR-003-22	22 8	15	95	33	95	527	88	16.0
KLR-003-26	26 8	21.2	122	42	115	610	95.5	21.5
KLR-003-32	32 8	31.5	140	52	146	777	150	79

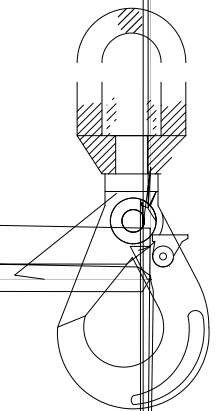

KLR-004 G80 SWIVEL SELF-LOCKING HOOK G80

		T	MM					KG
			A	B	C	D	E	
KLR-004-6	6-8	1.12	32.5	11.5	34.8	163.5	194.5	0.71
KLR-004-8	8-8	2	36	13	40	195	232	1.1
KLR-004-10	10-8	3.15	42	15.5	48	237	280.5	2.0
KLR-004-13	13-8	5.3	50	17	58	282	340	4.0
KLR-004-16	16-8	8	61	21.5	61	341.5	413.5	7.3
KLR-004-20	20-8	12.5	76	26.5	75.5	399.5	481	11.6
KLR-004-22	22-8	15	97	33	97	461	561	16.0
KLR-004-26	26-8	21.2	123	42	115	536.5	653.5	21.5

Never exceed Working Load Limit

G80 HOOKS



Forged super steel - Quenched Tempered
 Suitable for G80 China 80
 Individually proof test at 2.5 times Working Load Limit.
 Fatigue tested at 1.5 times Working Load Limit for 20000 cycles.
 Breakage twist.
 100% magnaflux crack detection on 100%
 With cast latch.
 Solour code(): Powder plastified()
 Ultimate load is 4 times the Working Load Limit.

2.5
 20000

4

KLR-005 G80 EUROPEAN TYPE EYE SLING HOOK WITH LATCH G80

		T	MM				KG
			A	B	C	E	
KLR-005-6	6-8	1.12	9	20	108	24	0.3
KLR-005-8	8-8	2	11	25	133	30	0.4
KLR-005-10	10-8	3.15	15	38	167	34	0.9
KLR-005-13	13-8	5.3	19	43	213	39	1.7
KLR-005-16	16-8	8	23	50	255	46	3.2
KLR-005-20	20-8	12.5	24	62	305	50	5.8
KLR-005-22	22-8	15	32	62	348	71	8.5
KLR-005-26	26-8	21.2	35	64	394	81	13
KLR-005-32	32-8	31.5	37	88	480	102	17



Forged super steel - Quenched Tempered
 Suitable for G80 China 80
 Individually proof test at 2.5 times Working Load Limit.
 Fatigue tested at 1.5 times Working Load Limit for 20000 cycles.

2.5
 20000

KLR-006 G80 EUROPEAN TYPE CLEVIS SLING HOOK WITH LATCH G80

		T	MM					KG
			A	B	C	D	E	
KLR-006-6	6-8	1.12	8	32	76	23	26	0.32
KLR-006-8	8-8	2	9.5	37	85.5	32.5	29	0.48
KLR-006-10	10-8	3.15	13	49	104	35	39	0.95
KLR-006-13	13-8	5.3	16.5	56.5	128	42.5	47	1.8
KLR-006-16	16-8	8	21.5	70.5	150	54	55	3.4
KLR-006-20	20-8	12.5	24	77	180	58	61	6.0
KLR-006-22	22-8	15	27	91	213	62	72	10.4
KLR-006-26	26-8	21.2	30	117	250	75	84	14.5
KLR-006-32	32-8	31.5	35	150	317	88	105	27.0

Never exceed Working Load Limit

G80 HOOKS



Forged super steel - Quenched Tempered.
 Suitable for G80 China 80
 Individually proof test at 2.5 times Working Load Limit. 2.5
 Fatigue tested at 1.5 times Working Load Limit for 20000 cycles. 20000
 Breakage twist.
 100% magnaflux crack detection 100%
 Surface code (): Powder plastified ()
 Ultimate load is 4 times the Working Load Limit. 4



Forged super steel - Quenched Tempered.
 Suitable for G80 China 80
 Fatigue tested at 1.5 times Working Load Limit for 20000 cycles.
 Breakage twist.
 100% magnaflux crack detection 100%
 Surface code (): Powder plastified ()
 Ultimate load is 4 times the Working Load Limit. 4



A

E

C

B

Never exceed Working Load Limit

For _____ g

AA

G80 HOOKS

Forged super steel - Quenched Tempered
Suitable for G80 China 80
Individually proof test at 2.5 times Working Load Limit. 2.5
Fatigue tested at 1.5 times Working Load Limit for 20000 cycles. 20000
Breakage twist.
100% magnaflux crack detection. 100%
With safety latch
Solour code(): Powder plastified()
Ultimate load is 4 times the Working Load Limit. 4



Never exceed Working Load Limit

G80 HOOKS



Forged super steel - Quenched Tempered.
 Breakage tvst.
 100% magnaflux crack geteci on 100%
 Wth forged latch
 Sol our code(): Powder plastified()
 Ultimate load is 4 times the Working Load Limit.

4

KLR-011 G80 C WELDED HOOK G80

	T	MM				KG
		A	B	C	E	
KLR-011-1	1	67	98	78	23.5	0.52
KLR-011-2	2	67	114	92	30	0.83
KLR-011-3	3	73.5	129	106	33.2	1.2
KLR-011-5	5	94	171	133	39	2.46
KLR-011-8	8	94	177	136.5	35	3.26
KLR-011-10	10	134.5	223	169.5	51	5.17

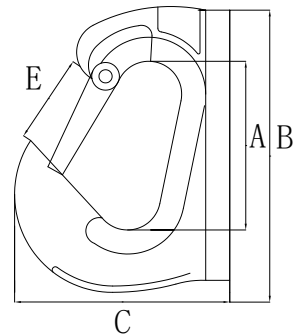

Forged super steel - Quenched Tempered.
 Individually proof test at 2.5 times Working Load Limit.
 Fatigue tested at 1.5 times Working Load Limit for 20000 cycles.
 Breakage tvst.
 100% magnaflux crack geteci on 100%
 Sol our code(): Powder plastified()
 Ultimate load is 4 times the Working Load Limit.

2.5

20000

4

KLR-012 G80 EYE CHOKER HOOK G80

		T	MM					KG
			A	B	C	D	E	
KLR-012-8	8-8	2	52	30.5	123	53.5	16	0.36
KLR-012-10	10-8	3.15	68	39	156	67.5	20	0.72
KLR-012-13	13-8	5.3	85	52	195	83	26	1.4
KLR-012-16	16-8	8	108	64	246	107	30	3.17
KLR-012-18	18-8	10	120.5	74.5	268.5	119	33.5	3.8
KLR-012-20	20-8	12.5	132	80	302	131	40	6.5
KLR-012-22	22-8	15	146	82	367	147	52	8.9

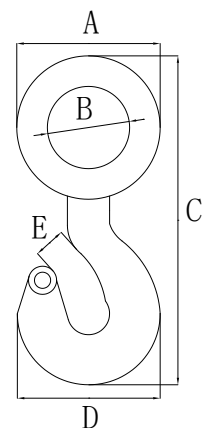

Never exceed Working Load Limit

G80 HOOKS

		T	MM					KG
			A	B	C	D	E	
KLR-013-1.6	3/8-1/2	1.6	50	132	71	17	21	0.68
KLR-013-2	5/8	2	63.5	151.5	79	22	23	1.21
KLR-013-3	3/4	3	69	170	103	28	29	1.99
KLR-013-5	1	5	85.7	213	135	32.5	38	4.18

		T	MM						KG
			A	B	C	D	E	F	
KLR-089-6	6-8	1.12	20.5	10	100	133	49	17	0.382
KLR-089-8	8-8	2	24	12	130	158.5	62	19	0.72
KLR-089-10	10-8	3.15	31.5	15	152.5	199	73	25	1.25
KLR-089-13	13-8	5.3	44	19	186	241.5	90	33	2.32
KLR-089-16	16-8	8	49	22	218	279	105	37	3.45
KLR-089-20	20-8	12.5	60	26	252	330	114	46	6.42

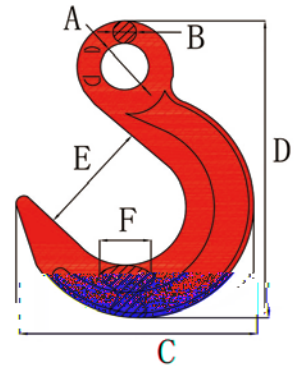

		T	MM					KG
			A	B	C	D	E	
KLR-090-8	8-8	2	9.5	37	128	161	63.4	1.1
KLR-090-10	10-8	3.15	13	39	156	190	77.1	1.37

		MM					



G80 HOOKS

KLR-081 G80 EYE GRAB HOOK G80

	T	MM					KG
		A	B	C	D	E	
KLR-081-1/4	1.2	13	54	19	81	8	0.13
KLR-081-9/32	2	15	64	23	98	9.5	0.27
KLR-081-3/8	3.2	20	82	30	125	12.5	0.55
KLR-081-1/2	5.4	25	106	42	165	17	1.3
KLR-081-5/8	8.2	30	127	49	196.5	20	2.48
KLR-081-3/4	12.8	34.5	152	56	231.6	23	3.8
KLR-081-7/8	15.5	40.5	175	65.6	267.6	28.6	5.8

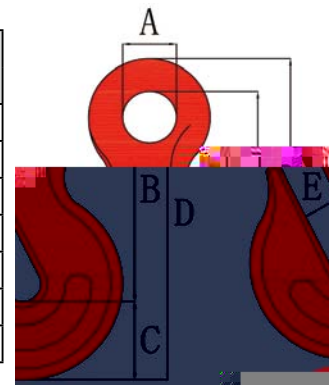

KLR-082 G80 CLEVIS GRAB HOOK G80

	T	MM						KG
		A	B	C	D	E	F	
KLR-082-1/4	1.2	8	34	57	19.5	8	90.5	0.22
KLR-082-9/32	2	9.5	41	65.3	23	9.5	106.5	0.31
KLR-082-3/8	3.2	12.7	46	82	31	12.5	137	0.7
KLR-082-1/2	5.4	16	61	113	43	16.7	184.5	1.8
KLR-082-5/8	8.2	19.5	68.5	129.5	49	20	215	3.1
KLR-082-3/4	12.8	24	88	152	58	24	254	4.1
KLR-082-7/8	15.5	27	96	178	64.8	26	295	6.2

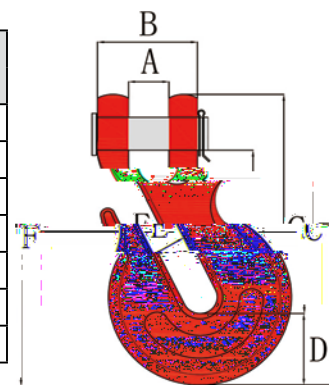

KLR-083 G80 EYE SHORTENING GRAB HOOK G80

		T	MM				KG
			A	B	C	E	
KLR-083-8	8-8	2	17	88.5	50	11	0.29
KLR-083-10	10-8	3.15	20	121.5	71	13	0.75
KLR-083-13	13-8	5.3	26	158	96	16.5	1.62

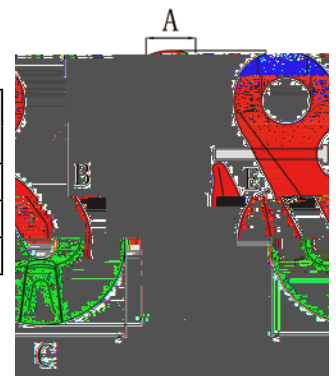

KLR-084 G80 CLEVIS SHORTENING GRAB HOOK G80

		T	MM				KG
			A	B	C	E	
KLR-084-6	6-8	1.12	8	43.5	75	8	0.28
KLR-084-8	8-8	2	9.5	49.5	89	11	0.33
KLR-084-10	10-8	3.15	12.5	70.5	126.5	13.2	0.88
KLR-084-13	13-8	5.3	15	90	163.5	16.5	1.85
KLR-084-16	16-8	8	19.5	112.5	183.5	19.2	3.24

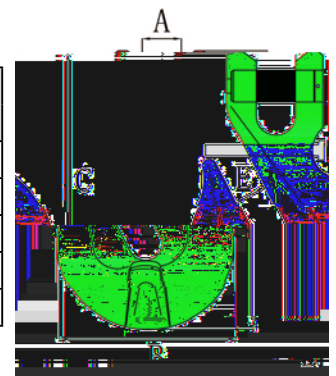

Never exceed Working Load Limit

G80 HOOKS

KLR-087 G80 DEEP THROAT EYE GRAB HOOK G80

		T	MM				KG
			A	B	C	E	
KLR-087-6	6-8	1.12	15	45	83	7	0.16
KLR-087-8	8-8	2	16	52	106.5	9.6	0.35
KLR-087-10	10-8	3.15	21	66	124.5	13	0.75

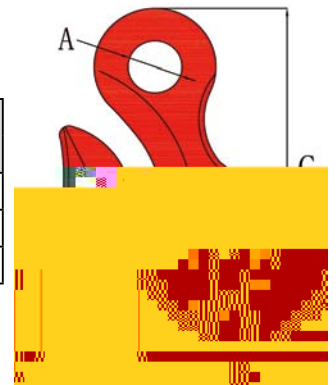

KLR-088 G80 DEEP THROAT CLEVIS GRAB HOOK G80

		T	MM				KG
			A	B	C	E	
KLR-088-6	6-8	1.12	7.5	45	85	7.5	0.19
KLR-088-8	8-8	2	9	57	106	10	0.35
KLR-088-10	10-8	3.15	12.5	74	127	13	0.75
KLR-088-13	13-8	5.3	15	89	165.5	15.5	1.63

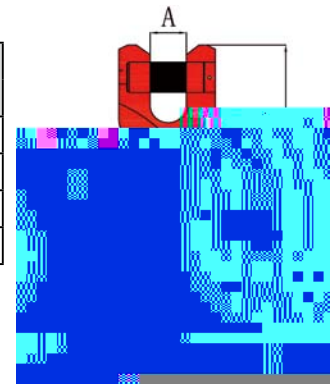

KLR-016 G80 CLEVIS FOREST HOOK G80

		T	MM				KG
			A	B	C	E	
KLR-016-6	6-8	1.12	8.5	31	83	8.5	0.35
KLR-016-8	8-8	2	9.5	35	95.5	10.5	0.41
KLR-016-10	10-8	3.15	13	44	137	13	0.92
KLR-016-13	13-8	5.3	16	53	165	16	1.75

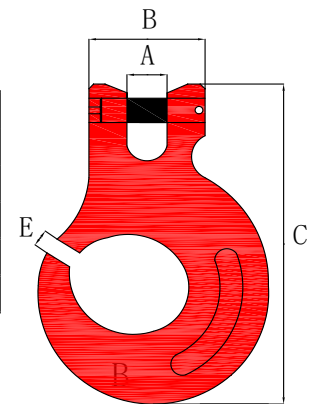

KLR-055 G80 CLEVIS HOOK G80 C

		T	MM					KG
			A	B	C	D	E	
KLR-091-8	8-8	2	9.5	35	28	136	20	0.57
KLR-091-10	10-8	3.15	13	46	39.5	189	29.5	1.4
KLR-091-13	13-8	5.3	16.5	59	52	246	39.5	3.0
KLR-091-16	16-8	8	18.5	72	59	298	46.5	5.4

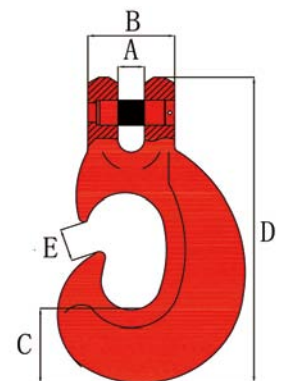

Never exceed Working Load Limit

G80 HOOKS

KLR-092 G80 CLEVIS CHAIN CLUTCH HOOK G80

		T	MM					KG
			A	B	C	D	E	
KLR-092-6	6-8	1.12	8	40	66	136.5	20	0.48
KLR-092-8	8-8	2	9.5	45	84	172.5	27	0.89
KLR-092-10	10-8	3.15	12	56.5	103	215	33	1.73
KLR-092-13	13-8	5.3	15	75	133.5	258	40	3.39
KLR-092-16	16-8	8	18.5	82	156.5	305	44	5.57

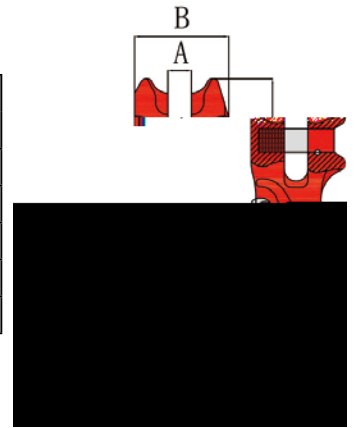

KLR-047 G80 TRACTOR HOOK G80

	T	MM				KG
		A	B	C	E	
KLR-047-8.5	8.5	30	145.5	270.5	40	5.45

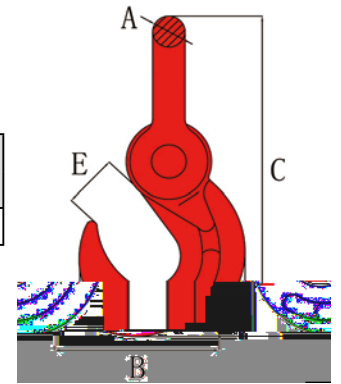

KLR-043 G80 CONTAINER HOOK RIGHI TYPE G80

	T	MM				KG
		A	B	C	D	
KLR-043-12.5	12.5	68	120.4	45	254.2	4.33
KLR-043-12.5	12.5	68	120.4	45	254.2	4.33
KLR-043-12.5	12.5	68	120.4	45	254.2	4.33

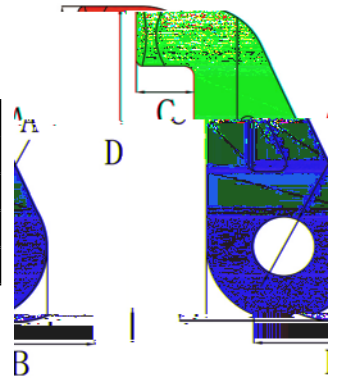

KLR-056 G80 LASHING TYPE C HOOK G80 C

		T	MM				KG
			A	B	C	D	
KLR-056-9	9mm	2.5	13.5	18.5	90.5	143	0.5
KLR-056-11	11mm	3.75	15.5	22	109.5	177	0.85
KLR-056-13	13mm	5.4	17.5	25.5	129	205	1.38

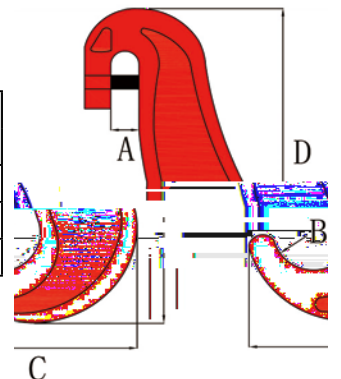

*

Never exceed Working Load Limit

HOOKS

	T	MM					KG
		A	B	C	D	E	
KLR-017-1	1	19	82	19	110	22	0.28
KLR-017-2	2	28	103	26	140.5	24	0.65
KLR-017-3	3	31	119	28	162	27.5	0.94
KLR-017-5	5	39	146	37	201	33	1.95
KLR-017-7	7	51	186.5	46.5	256	40	3.77
KLR-017-11	11	62	231.5	57	317	51	6.8
KLR-017-15	15	73	261	67	360	57	9.8
KLR-017-22	22	89	318	76	434	75	16.5
KLR-017-30	30	90	360	92	495.5	98	29.2
KLR-017-50	50	120	520	142	727	148.5	88

	T	MM					KG
		A	B	C	D	E	
KLR-018-0.5	0.5	16.5	72	17	97	19	0.21
KLR-018-1	1	23	93.5	21	125	23	0.4
KLR-018-2	2	31	119	28	162	27.5	0.94
KLR-018-3	3	39	146	37	201	33	1.95
KLR-018-5	5	51	186.5	46.5	256	40	3.77
KLR-018-8	8	58	231.5	57	315	51	6.5

Never exceed Working Load Limit

HOOKS

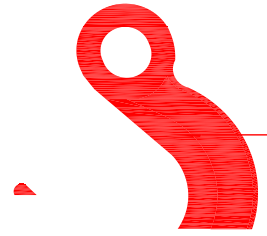

Never exceed Working Load Limit

HOOKS

KLR-021 EYE SLIP HOOK WITH LATCH

	IBS	MM					IBS
		A	B	C	D	E	
KLR-021-1/4	2750	12.7	65	92	68.5	23	0.40
KLR-021-5/16	4300	16	72.5	106	76	26	0.62
KLR-021-3/8	5250	18	86.5	124	89.5	33	1.11
KLR-021-7/16	7000	20.5	98.5	142	108	40	1.56
KLR-021-1/2	9000	23	109.5	156	116.5	43	2.10
KLR-021-5/8	13500	28.8	132.5	195	143	52	3.90
KLR-021-3/4	19250	35	147.5	222	169	55	6.93

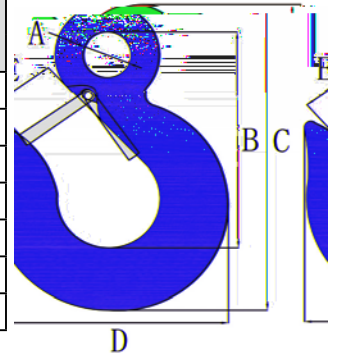

*

KLR-022 CLEVIS SLIP HOOK WITH LATCH

	IBS	MM						IBS
		A	B	C	D	E	F	
KLR-022-1/4	2750	11	27	66	22	21.5	103.5	0.55
KLR-022-5/16	4300	13	33	73	26	25.5	117	0.82
KLR-022-3/8	5250	15	39	84.5	29.5	33.5	134	1.26
KLR-022-7/16	7000	16	44	93	34.5	36	151.5	2.25
KLR-022-1/2	9000	19	48	100	43	37.5	168	3.06
KLR-022-5/8	13500	18.5	58.7	125	46	46.5	200.5	5.18
KLR-022-3/4	19250	30.5	81	156.5	60	58	257	12.4

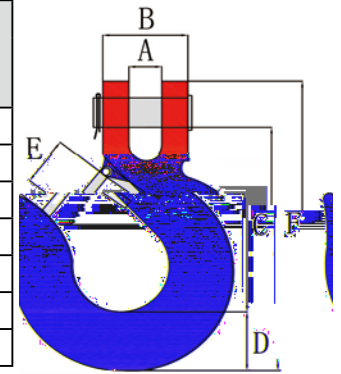

*

KLR-023 "S" HOOK S

	T	MM				KG
		A	B	C	E	
KLR-023-1	1	26	77	166	23.8	1.2
KLR-023-2	2	28	84	175	26	1.5
KLR-023-3	3	30	90	188	30	2
KLR-023-5	5	38	120	238	38	4.5
KLR-023-8	8	50	160	305	55	8.8
KLR-023-10	10	53	181	361	70	12

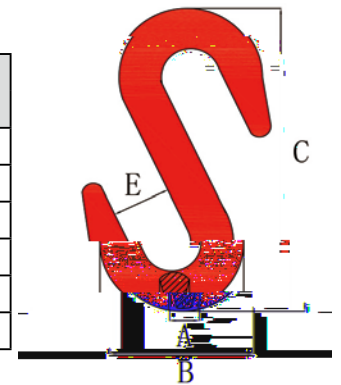

KLR-024 "G" TYPE HOOK G

	T	MM				KG
		A	B	C	E	
KLR-024-1	1	17	91	57	11.5	0.33
KLR-024-1.5	1.5	20	107	66	13	0.6
KLR-024-3.2	3.2	26	123	77	15	0.9
KLR-024-5.6	5.6	38	180	115	23	3.1

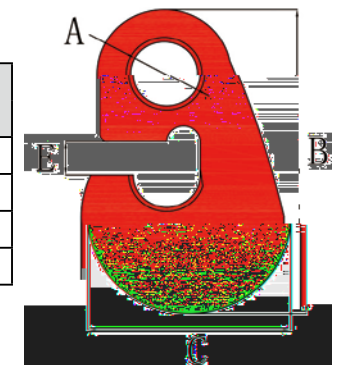

Never exceed Working Load Limit

HOOKS

KLR-025 EYE GRAB HOOK

	IBS	MM					IBS
		A	B	C	D	E	
KLR-025-1/4	3500	13	50.5	18.5	77	9	0.28
KLR-025-5/16	4700	14	56.8	22.7	89	11.5	0.45
KLR-025-3/8	7100	17	65.2	28.3	104	13	0.79
KLR-025-1/2	12000	22	85.5	37.5	135	17	1.75
KLR-025-5/8	15800	30	116	45	180	21	3.25
KLR-025-3/4	24700	35	133.5	55	211	25	5.95

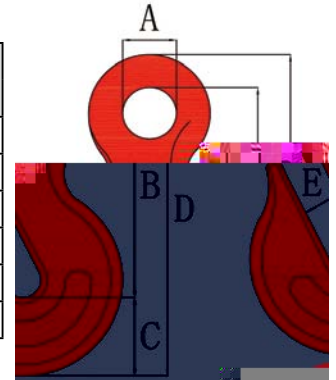

*

KLR-026 CLEVIS GRAB HOOK

	IBS	MM						IBS
		A	B	C	D	E	F	
KLR-026-1/4	3500	8.5	25	44.7	19	9.2	78.5	0.36
KLR-026-5/16	4700	10	30.5	54.1	25	11.2	93	0.62
KLR-026-3/8	7100	13	35	67.2	28.3	12.7	114.5	1.00
KLR-026-7/16	8750	17	42	70	33.5	14.5	126	1.50
KLR-026-1/2	12000	19	47	81.6	38	17	144	2.22
KLR-026-5/8	15800	23	56	102.5	45	20	177	4.41
KLR-026-3/4	24700	24	66.5	118	54	24	207.5	6.50

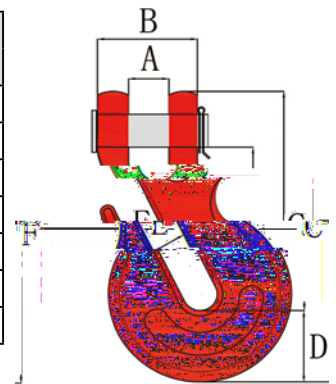

*

KLR-027 STRAIGHT SHANK HOOK

	MM	MM				
		A	B	C	D	E
KLR-027-20	20	56	144	24	84.5	28
KLR-027-24	24	59	167	31.5	104	34
KLR-027-30	30	69	197	40.5	131	40
KLR-027-36	36	78	224	48	148.5	45
KLR-027-42	42	86	253	58.5	171.5	50
KLR-027-48	48	95	285	68	197	56
KLR-027-53	53	103	318	76	222	63
KLR-027-60	60	140	380	86	248	71
KLR-027-67	67	147	418	96	279	80
KLR-027-75	75	166	452	107	308	90
KLR-027-85	85	225	510	118	342	100
KLR-027-95	95	265	582	132	388	112

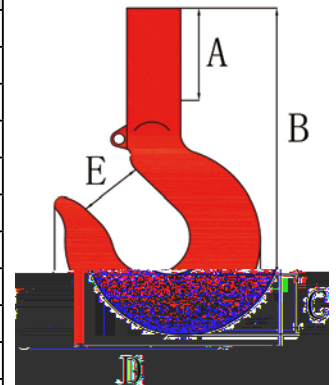

Never exceed Working Load Limit

HOOKS

KLR-030 OIL SWIVEL HOOK

	T	MM				KG
		A	B	C	E	
KLR-030-2	2	63	84	356	35	3.5
KLR-030-3	3	88	90	410	44	7.1
KLR-030-5	5	105	108	515	51	13.5
KLR-030-8	8	127	160	630	62	24.5

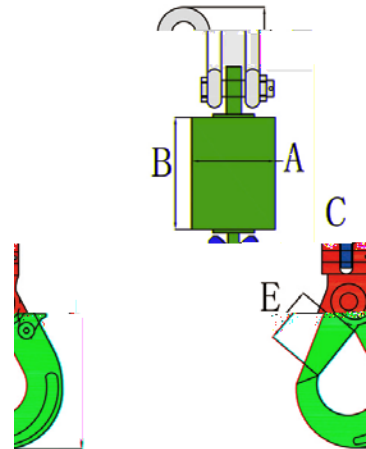

KLR-031 UNIVERSAL VERTICAL HOOK RING

	T	MM						
		A	B	C	D	E	F	G
KLR-031-1	1	67	80	275	99.5	31	42	26
KLR-031-2	2	78	100	360	121.5	35	56	37
KLR-031-3	3	88	111	415	139	40	69	38
KLR-031-5	5	108	122	490	165.5	48	88	50
KLR-031-8	8	128	200	640	210	60	112	65
KLR-031-10	10	147	220	740	237	66	117	71

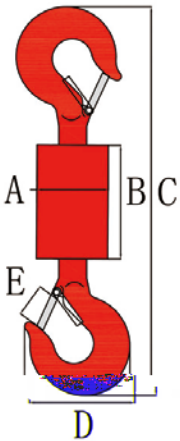
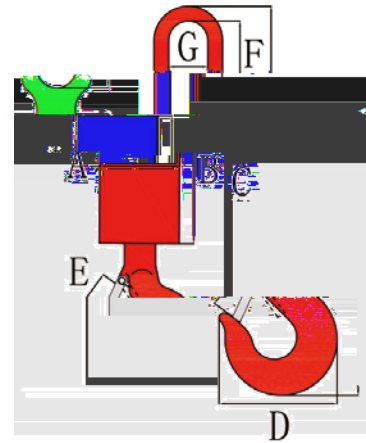

KLR-032 UNIVERSAL VERTICAL DOUBLE HOOKS

	T	MM				
		A	B	C	D	E
KLR-032-1	1	67	80	300	99.5	31
KLR-032-2	2	78	100	390	121.5	35
KLR-032-3	3	88	111	451	139	40
KLR-032-5	5	108	122	492	165.5	48
KLR-032-8	8	128	200	710	210	60
KLR-032-10	10	147	220	760	237	66

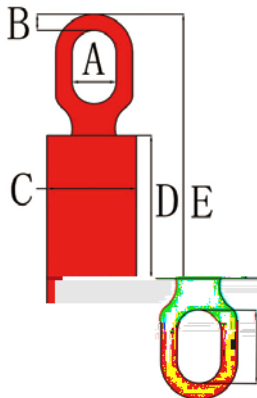

KLR-033 UNIVERSAL VERTICAL HEAVY RING

	T	MM					
		A	B	C	D	E	F
KLR-033-1	1	26	15	67	80	250	42
KLR-033-2	2	37	19	78	100	310	56
KLR-033-3	3	38	25	88	111	401	69
KLR-033-5	5	50	31	108	122	472	88
KLR-033-8	8	65	34	128	200	610	112
KLR-033-10	10	71	42	147	220	710	117

Never exceed Working Load Limit

HOOKS

KLR-040 AUS. CLEVIS SHORTENING GRAB HOOK

	T	MM				KG
		A	B	C	E	
KLR-040-1/4	1	8	7.9	45	8.8	0.20
KLR-040-5/16	2	10	9.6	49.6	10.5	0.36
KLR-040-3/8	3	13.5	11.8	65	13.0	0.60
KLR-040-1/2	5	17	16.0	83	17.0	1.09

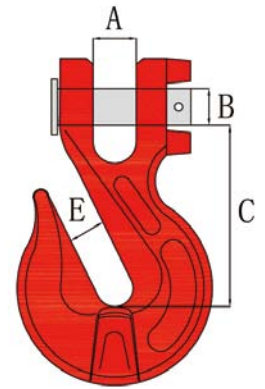

KLR-041 EYE BEND HOOK

	T	MM				KG
		A	B	C	E	
KLR-041-5/16	4.54	12.5	58.1	77.9	10.2	0.37
KLR-041-3/8	16	21.7	67.2	120	12.8	0.63

*

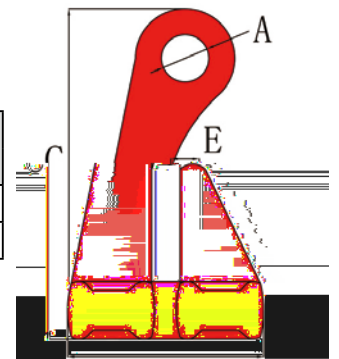

KLR-042 CLEVIS BEND HOOK

	T	MM				KG
		A	B	C	E	
KLR-042-5/16	4.54	11	58	120.5	11.8	0.45

*

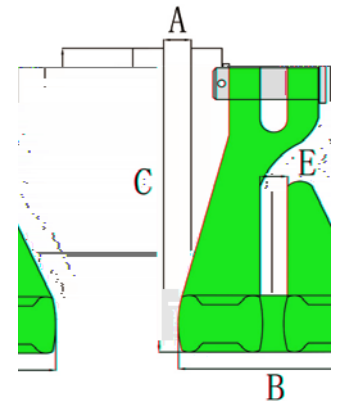

KLR-029 NASAL TYPE HOOK

	T	MM					KG
		A	B	C	D	E	
KLR-029-1	1	16	17	80	20	25	1.3
KLR-029-2	2	18	24	90	24	32	2.1
KLR-029-3	3	22	31	102	28	40	2.7
KLR-029-5	5	33	38	140	38	62	3.5
KLR-029-8	8	38	46	168	46	70	5.9
KLR-029-10	10	42	50	188	50	80	11

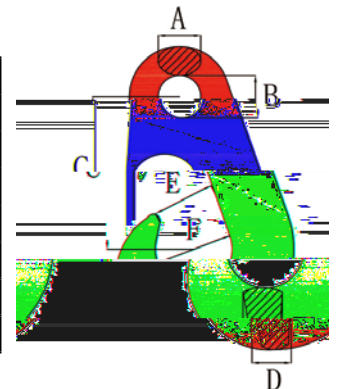

Never exceed Working Load Limit

HOOKS

KLR-044 ALLOY SORTING HOOK

	T	MM					KG
		A	B	C	D	E	
KLR-044-2	2	35	49	170	254	33	3.09



KLR-045 FORGED BARREL HOOK

	T	MM				KG
		A	B	C	D	
KLR-045-1	1	38	71	60	118.5	0.7
KLR-045-2	2	40	66	50	128	0.55

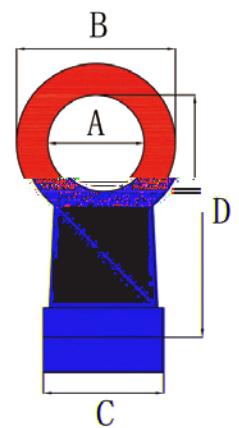

KLR-054 EYE WEBBING SLING HOOK

	T	MM				KG
		A	B	C	E	
KLR-054-1.6	1.6	55	111	150	33	1.2

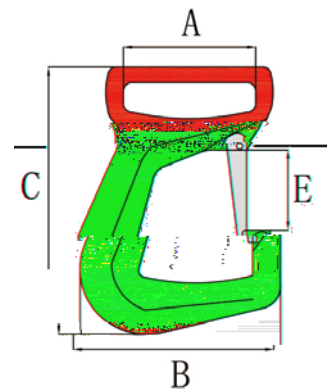

KLR-099 WEBBING SLING HOOK

	T	MM				KG
		A	B	C	E	
KLR-099-2.2	2.2	61	120	167	47	1.48

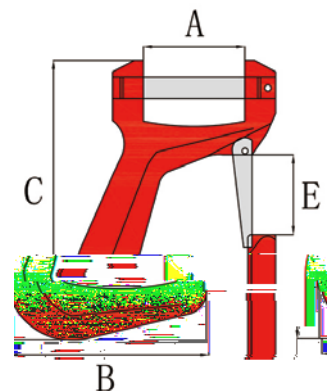

Never exceed Working Load Limit

HOOKS

KLR-048 EYE TWIST HOOK

	T	MM				KG
		A	B	C	E	
KLR-048-8	8	44.5	170	303	39	6.15

*

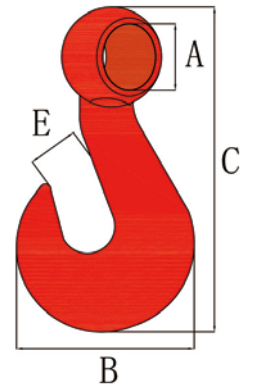

KLR-051 ALLOY LARGE OPENING HOOK

	T	MM				KG
		A	B	C	E	
KLR-051-1.5	1.5	40	112	272	99	1.27

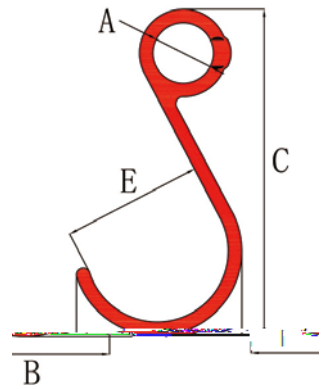

KLR-057 ALLOY EYE HOOK WITH LATCH

	T	MM				KG
		A	B	C	E	
KLR-057-1.5	1.5	22.5	121.5	151	41.5	0.4

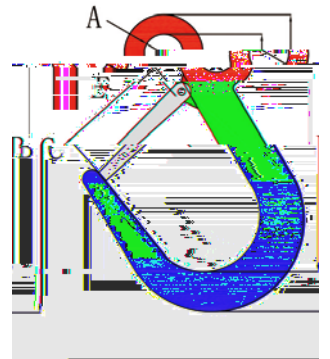

KLR-058 J HOOK J

	IN	T	MM				KG
			A	B	C	E	
KLR-058-8	8	2.45	19.5	32	162	146	1.5
KLR-058-15	15	2.45	19.5	32	318.2	157.3	2.0

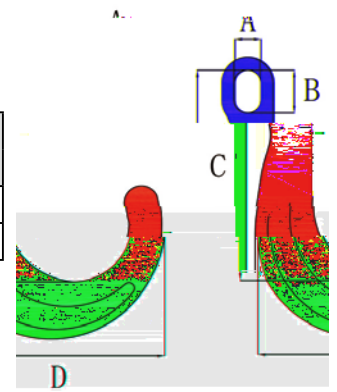

Never exceed Working Load Limit

HOOKS

- 1.
- 2.
- 3.
- 4.
- 5.
- 6.
- 7.

90 4 10% 3 2 1
 45 5

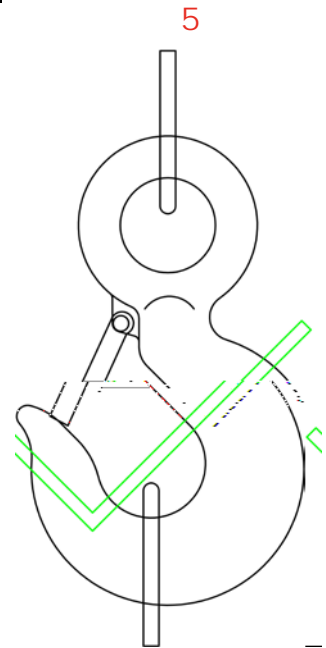
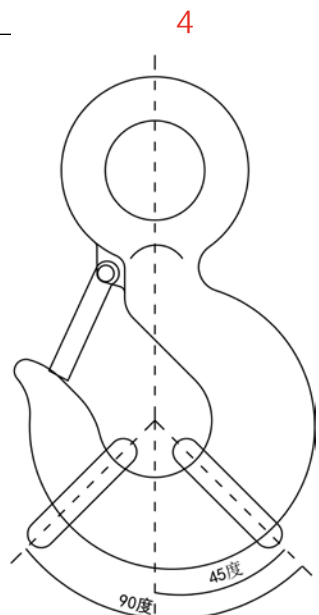
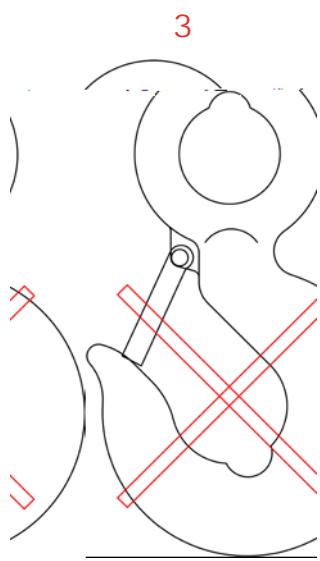
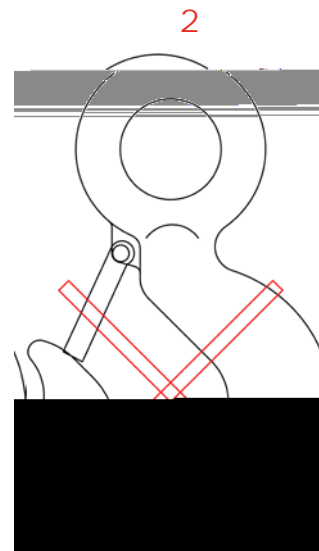
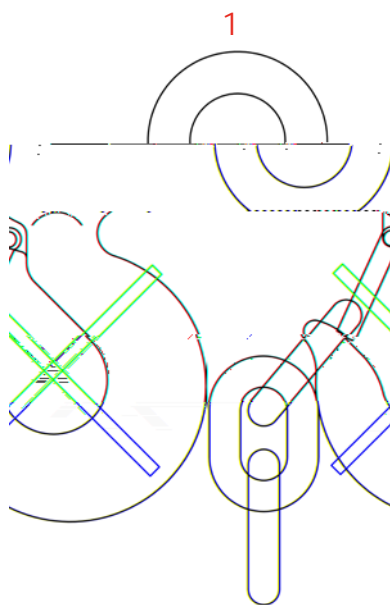

Never exceed Working Load Limit